

DATA SHEET

CODICE ARTICOLO F-L262520

Specification

Norminal Voltage	12V	
Norminal Capacity(20Hr)	62Ah	
EN CCA(Cold Cranking Amphere)	520A	
Dimension	Length	242mm
	Width	174mm
	Container Height	189mm
	Total Height (with Terminal)	189mm
Approximate Weight	Approx 14.3kg	
Terminal Shape	Standard shape according to EN standard	
Terminal Layout	Layout 0	
Container Material	PP(polypropylene)	
Norminal Operating Temp. Range	25±3 °C (77±5 °F)	
Capacity affected by Temperature	40 °C (104 °F)	105%
	25 °C (77 °F)	100%
	0 °C (32 °F)	85%

Self-discharge Characteristic

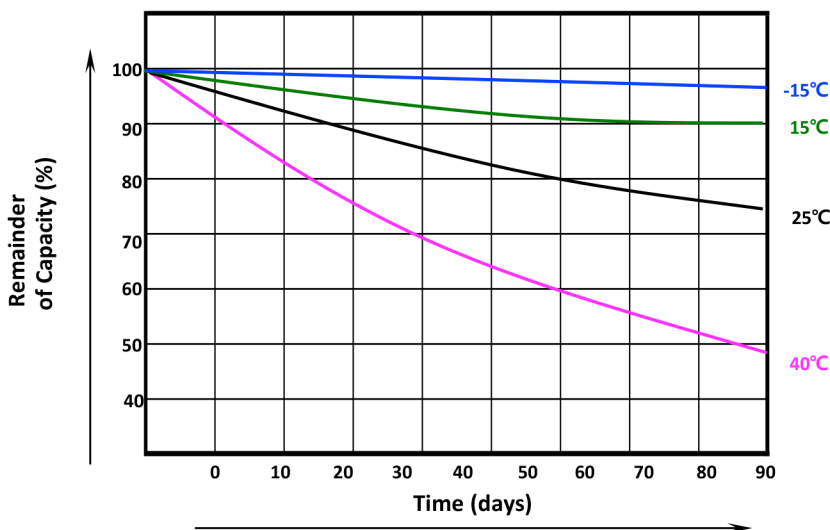

Test definition (EN50342:2001)

EN CCA : The battery is required to meet a voltage of 7.5V after 10 seconds and after 10 seconds rest, the battery is further discharged @ 0.6 x original current and is required to complete 73s until 6V in the second stage giving a total combined discharge period of 90 seconds [assume initial period equates to (10s/0.6) 16.7 seconds.]

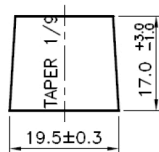
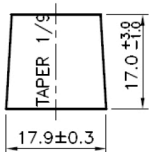
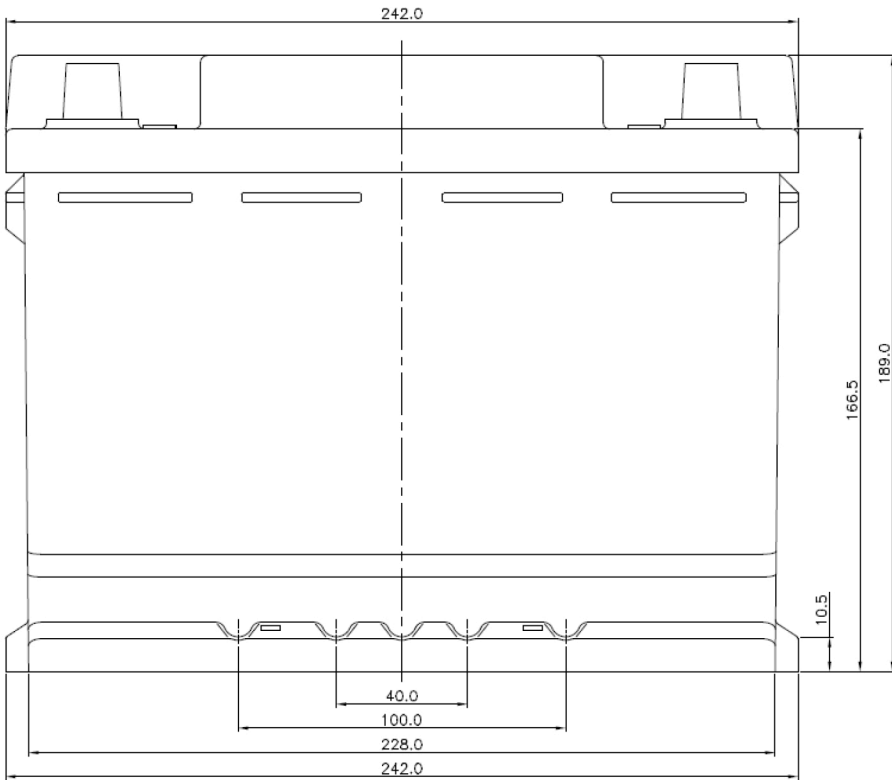
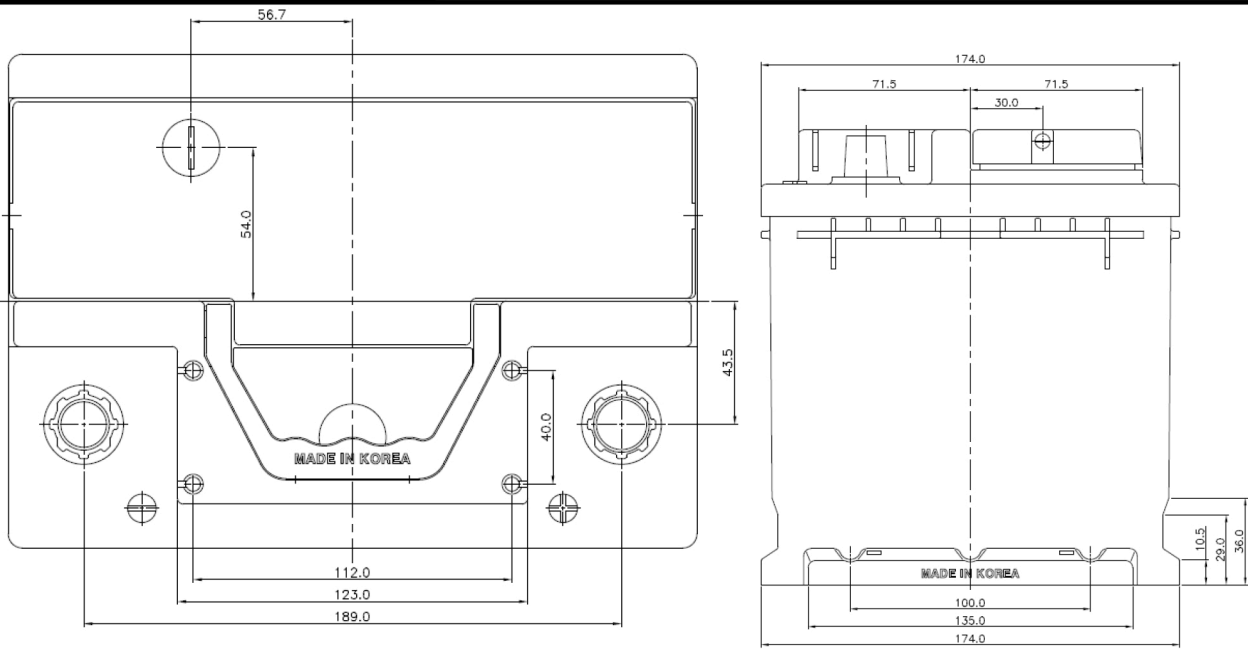

NEGATIVE TERMINAL

POSITIVE TERMINAL